





Single-pole switch

Box Size: 12.5 cu. in., Metal Box Type: 3" x 2" x 2-1/2" Device, Plastic Box Type: 18 cu.

Key: Black 
 Red 
 White 
 Ground 

Circuit diagrams demonstrate the basic switching and branching in household lights, switch. They do not account for load -- the amount of power used.

The Simulator does not check for unused, bare wires in a box. Always remove them or cap the connectors in wiring your own circuitry.

Diagrams in this program depict grounding for metal boxes with non-metallic cable. Plastic require a ground to the box. Metal conduit systems require a ground from the box to all de Plastic boxes are not permitted for use with armored cable or conduit.



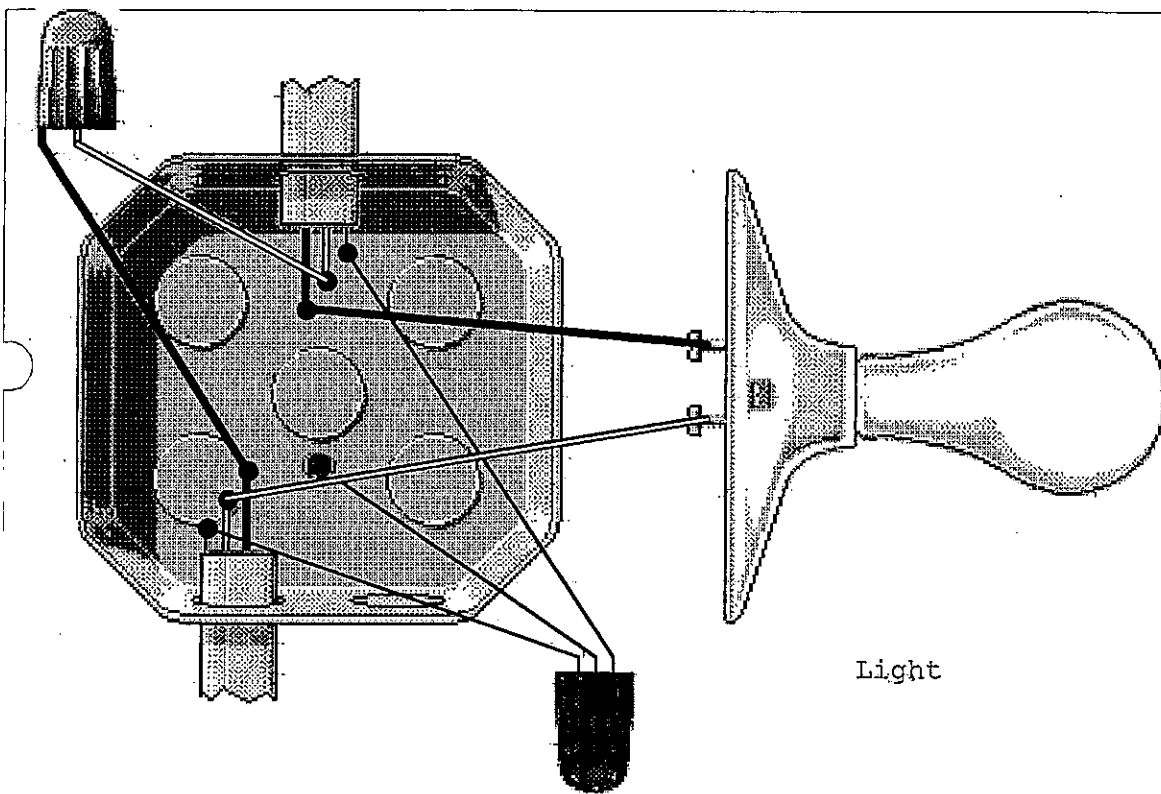
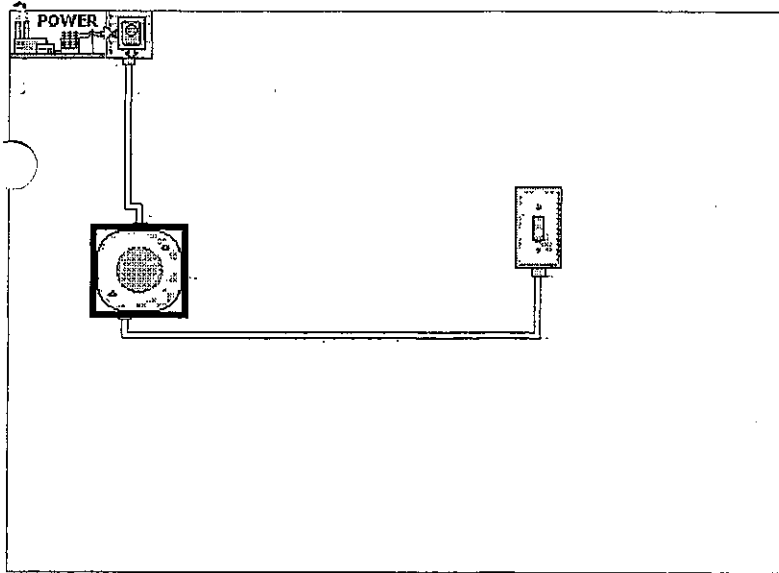

Red wire (longest wire emerging from cable) may print as white or black on some printers. path carefully before wiring.

Always obtain the proper permits for electrical work, and comply with local regulations.



Light

Box Size: 17.5 cu. in., Metal Box Type: 2" x 2-1/8" Round, Plastic Box Type: 4" Round

Key: Black 
 Red 
 White 
 Ground 

Circuit diagrams demonstrate the basic switching and branching in household lights, switch. They do not account for load -- the amount of power used.

The Simulator does not check for unused, bare wires in a box. Always remove them or cap them with connectors in wiring your own circuitry.



Diagrams in this program depict grounding for metal boxes with non-metallic cable. Plastic require a ground to the box. Metal conduit systems require a ground from the box to all de Plastic boxes are not permitted for use with armored cable or conduit.

Red wire (longest wire emerging from cable) may print as white or black on some printers. path carefully before wiring.

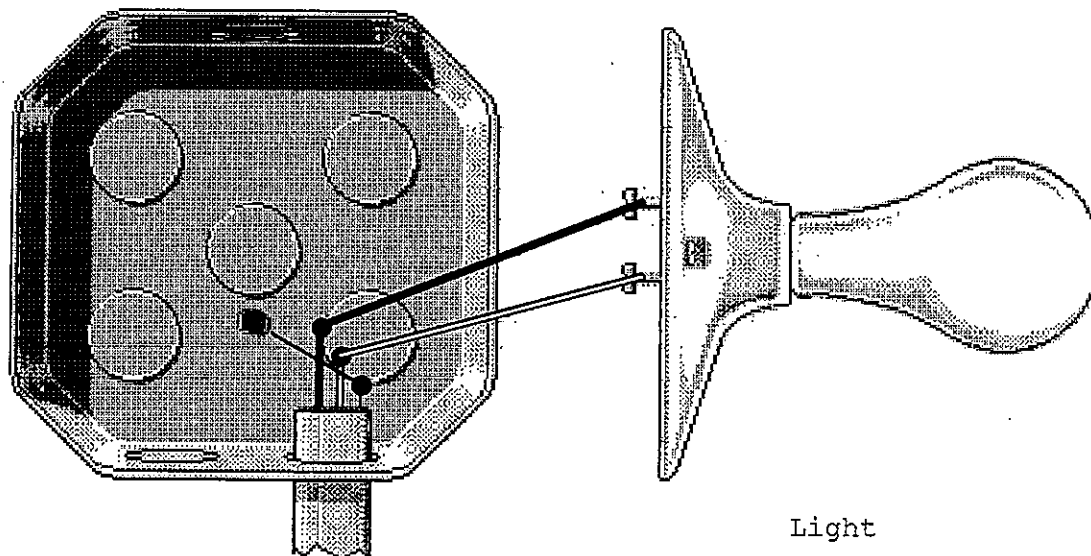
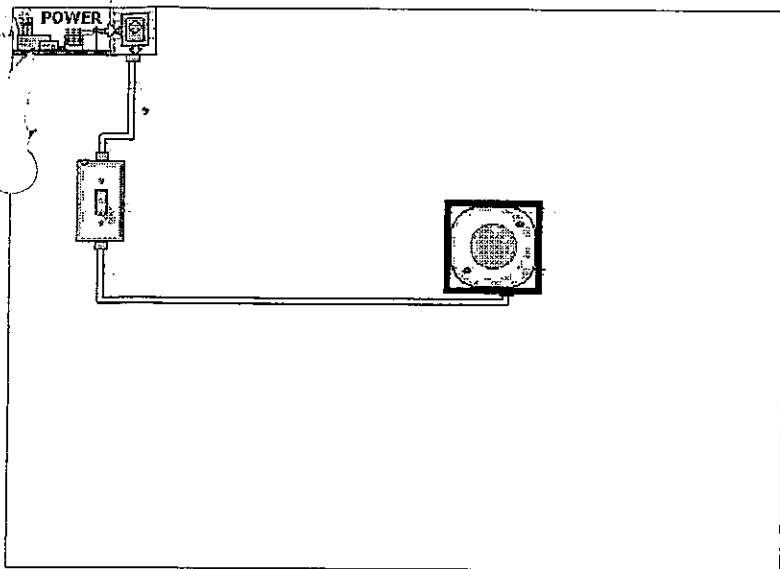
Always obtain the proper permits for electrical work, and comply with local regulations.

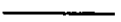

Box Size: 12.5 cu. in., Metal Box Type: 4" x 1-1/4" Round, Plastic Box Type: 4" Round

Key: Black 
 Red 
 White 
 Ground 

Circuit diagrams demonstrate the basic switching and branching in household lights, switches. They do not account for load -- the amount of power used.

The Simulator does not check for unused, bare wires in a box. Always remove them or cap the connectors in wiring your own circuitry.

Diagrams in this program depict grounding for metal boxes with non-metallic cable. Plastic boxes require a ground to the box. Metal conduit systems require a ground from the box to all devices. Plastic boxes are not permitted for use with armored cable or conduit.

Red wire (longest wire emerging from cable) may print as white or black on some printers. Follow the path carefully before wiring.

Always obtain the proper permits for electrical work, and comply with local regulations.

11/11/11